

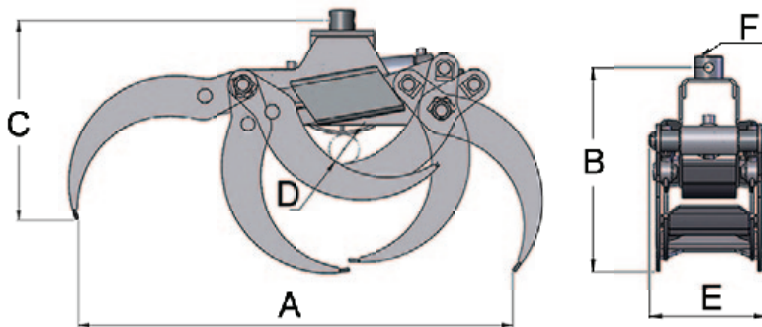









# TG 22-50

**TIGERgrip**

A	1310
B	544
C	606
D	90
E	311
F	50/25

								
TG 22	98	3	0,22	200	IVR 3	1	50	13,5



**MECANIL OY AB**  
 Valtatie 565  
 07880 Liljendal

Puh. (019) 661 2600  
 Fax (019) 616 643

[mecanil@mecanil.fi](mailto:mecanil@mecanil.fi)  
[www.mecanil.fi](http://www.mecanil.fi)